

CILINDRO CHAMPIONS® C43-C44 CYLINDER

LISTINO GENNAIO 2012 - PRICE LIST JANUARY 2012



CHAMPIONS
NEW GENERATION HIGH SECURITY CYLINDERS

multidea



SAFEGUARDING YOUR SECURITY

MADE
IN
ITALY

CHAMPIONS® C43 - C44
doppio sistema di
cifatura meccanica,
milioni di combinazioni
e duplicazione chiavi riservata
ai MOTTURA CLUB



*CHAMPIONS® C43 - C44
double mechanical coding system,
millions of combinations
and keys duplication only
at MOTTURA CLUB*



- Dotazione :
- N.3 chiavi in confezione sigillata
 - Tessera di proprietà
 - Vite di fissaggio
 - Finitura nichel satinato

- Supplied with :
- 3 keys in sealed packet
 - Owner's card
 - Fixing screw
 - Satin nickel finish



PERSONALIZZAZIONE DELLA CHIAVI

Possibilità di personalizzare le chiavi mediante inserti colorati intercambiabili.

PERSONALIZING THE KEYS

The keys can be personalized with interchangeable coloured inserts.



MOTTURA PATENT



PROFILO CHIAVE "MM" MOTTURA

Il profilo della chiave "MM" è un marchio registrato e depositato a garanzia di una maggiore sicurezza contro la duplicazione illecita delle chiavi.

MOTTURA "MM" KEY PROFILE

The "MM" key profile is a registered trademark that guarantees higher security against illegal key duplication.

CHIAVE IN ALPACCA REVERSIBILE E COSTAMPATA

Il gambo in alpacca forma un corpo unico con la testa della chiave, rivestita dall'impugnatura in plastica, ergonomica e di minimo ingombro.

NICKEL SILVER REVERSIBLE DIE-CAST KEY

The nickel silver shaft forms a single piece with the key head which is covered with a thin, ergonomic plastic grip.

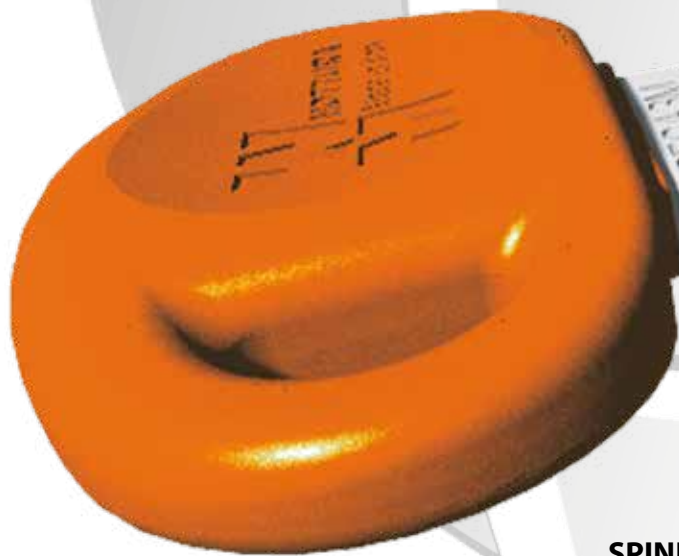

SPINE IN ACCIAIO STEEL PINS

CHAMPIONS® 43



CHAMPIONS® 44 con corpo protetto da uno speciale rinforzo a cerniera brevettato.



CHAMPIONS® 44 with shell protected by a special patented hinged anti-wrench reinforcement.

CHAMPIONS® 44

DISPOSITIVI DI PROTEZIONE CONTRO LA FORATURA

Corpo e rotore di CHAMPIONS® 43-44 sono protetti da spine, sfere, perni e tappi di elevata durezza; elementi perfettamente integrati e liberi di muoversi per contrastare l'azione del trapano.

DRILLING PROTECTIONS

Body and plug are protected with hardened caps, pins and balls, which are perfectly integrated and move freely to protect effectively against drilling.

TRATTAMENTO ANTIUSURA

Uno speciale rivestimento aumenta l'efficienza e la durata dei principali elementi mobili di CHAMPIONS® 43-44.

WEARPROOF TREATMENT

A special treatment enhances efficiency and duration of the mobile elements of CHAMPIONS® 43-44.

SISTEMA MECCANICO BREVETTATO MOTTURA

CHAMPIONS® 43-44 abbina due diversi sistemi di cifratura: uno tradizionale a cinque pistoncini e uno costituito da quattro perni rotanti con anima in acciaio di elevata durezza. Il particolare sistema di guida dei perni (brevettato), liberi di ruotare e senza molle, le false tacche antisondaggio presenti sui perni stessi e l'elevato numero di combinazioni possibili rendono estremamente difficile manipolare e decodificare la cifratura.

MOTTURA PATENTED MECHANICAL CODING SYSTEM

CHAMPIONS® 43-44 combines two different coding systems: a traditional one with 5 pins and one with 4 rotating steel pins. The special guide system (patented) let the pins rotate freely and without springs, the false antipicking notches on the pin and the extensive number of combinations make picking extremely difficult.

ANTI-BUMPING

I cilindri contrassegnati con la sigla "BKC" sono certificati "resistenti al bumping".

ANTI BUMP-KEY SYSTEM

The cylinders certified as BUMP-RESISTANT are marked "BKC" on the label.

POSIZIONE DELLA PENNA SFALSATA "ANTISFILAMENTO"

La posizione a riposo della penna, sfalsata di 30 gradi rispetto al profilo del cilindro, ne ostacola la fuoriuscita in caso di estrazione forzata.

POSITION OF THE CAM

Cam rest position, 30° off-centre with respect to the cylinder profile, prevents forced extraction.

PERNO E CONTROPERNO CON SAGOMATURA ANTIGRIMALDELLO

Rendono più difficoltosa la manipolazione.

TOP AND BOTTOM MUSHROOM PINS

Make picking extremely difficult.

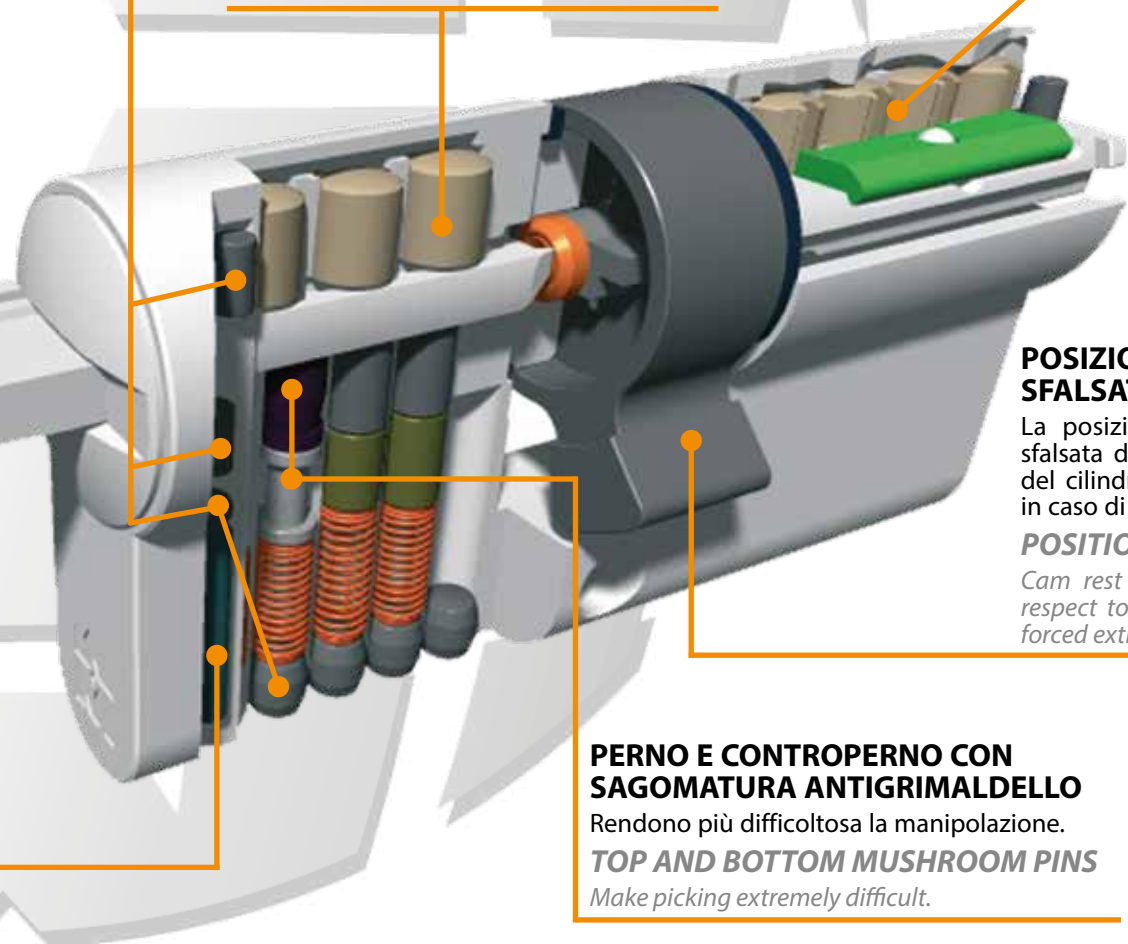

DUPLICAZIONE CHIAVI PROTETTA E CERTIFICATA CATEGORIA 2 PROTECTED KEY CERTIFIED DUPLICATION CATEGORY 2



La **duplicazione** delle chiavi **CHAMPIONS® 43-44** viene gestita tramite **MOTTURA CLUB**, i quali sono in possesso delle chiavi grezze, con le piste desmodromiche già fresate e quindi pronte per la duplicazione.

Le chiavi sono accompagnate da una **carta di proprietà** numerata, da esibire sempre al rivenditore autorizzato per ogni richiesta di duplicato.

La carta di proprietà corrisponde sempre ad ogni set di chiavi originali: i numeri riportati sulla card coincidono con i numeri stampati sulle chiavi.

La **carta di proprietà** è quindi l'unico documento che permette di richiedere un duplicato e va conservata con cura in un luogo sicuro, per evitare che chi ne entri in possesso anche per poco tempo possa richiedere dei duplicati in modo illecito.

ATTENZIONE! In caso di smarrimento della carta di proprietà **NON** si effettuano duplicati.



Keys for **CHAMPIONS® 43-44** cylinders are duplicated only by authorized **MOTTURA CLUB**, which have blank keys with the track already milled and ready for duplication.

The keys are supplied with a numbered **owner's card**, to be showed at the authorized **MOTTURA CLUB** centre whenever a duplicate is requested.

The **owner's card** always corresponds to the set of original keys: the numbers printed on the card are the same as the ones printed on the keys.

The **owner's card** is the only document that can be used to obtain duplicates, and must be stored carefully, in a safe place, to prevent unauthorized duplication.

WARNING! In the event of card loss, it will **NOT** be possible to duplicate keys.

DUPLICAZIONE CHIAVI C43-C44

Le chiavi grezze avranno già la pista desmodromica fresata, pronte per la duplicazione.

- Clienti che hanno la Multicode:
 - invio dischetto con le cifrature assegnate che permetterà di duplicare le chiavi **"a codice"**.
- Clienti che non hanno la Multicode:
 - potranno duplicare le chiavi relative alle loro piste **"a copia"** utilizzando una macchina predisposta.

DUPLICATION OF C43-C44 KEYS

Blanks already have the mechanical coding system and ready for duplication.

- Customers who have the Multicode:
 - send the disc with assigned codes to allow duplication of **"coded"** keys
- Customers who do not have the Multicode:
 - can duplicate keys for their tracks **"by copy"** on an appropriately equipped machine.

MOTTURA è la prima a **certificare la duplicazione delle chiavi** per i cilindri CHAMPIONS® tramite l'ICIM, ente esterno che verifica che le duplicazioni avvengano con le modalità richieste A TUTELA DEL CONSUMATORE.



MOTTURA is the first company that certifies the key duplication for CHAMPIONS® cylinders through ICIM, an external agency that verifies that all duplications are made according to the standard requested for highest protection of consumer security.

Classificazione cilindri di sicurezza Security cylinders classification (UNI EN 1303:05)

Categoria d'uso	Prova ciclica	Massa della porta e forza di chiusura	Idoneità d'uso su porte taglia fumo/fuoco	Sicurezza	Resistenza alla corrosione	Sicurezza della chiave	Resistenza alla foratura e attacchi meccanici	Resistenza alla manipolazione Picking resistance	Resistenza al "bumping" Bumping resistance	DUPLICAZIONE CHIAVI CERTIFICATA CATEGORIA 2
Category of use	Durability	Door mass and closing force	Suitability for use on fire/smoke doors	Security	Corrosion resistance	Key related security	Drill and mechanic attack resistance			
1	6	0	1	0	C	6	2	◆	1	CERTIFIED KEY DUPLICATION CATEGORY 2



CHAMPIONS® C43

Cilindro di sicurezza chiave/chiave Double cylinder

Dotazione:

- N. 3 chiavi in confezione sigillata
- Tessera duplicazione chiavi
- Vite di fissaggio
- Finitura nichel satinato

Supplied with:

- 3 keys in a sealed packet
- Owner's card
- Fixing screw
- Satin nickel finish



Art. / Art.	A	B - C
C43D313101	62	31-31
C43D313601	67	31-36
C43D314101	72	31-41
C43D363601	72	36-36
C43D314601	77	31-46
C43D364101	77	36-41
C43D315101	82	31-51
C43D364601	82	36-46
C43D414101	82	41-41
C43D315601	87	31-56
C43D365101	87	36-51
C43D414601	87	41-46
C43D316101	92	31-61
C43D365601	92	36-56
C43D415101	92	41-51
C43D464601	92	46-46
C43D316601	97	31-66

Art. / Art.	A	B - C
C43D366101	97	36-61
C43D415601	97	41-56
C43D465101	97	46-51
C43D317101	102	31-71
C43D416101	102	41-61
C43D465601	102	46-56
C43D515101	102	51-51
C43D466101	107	46-61
C43D515601	107	51-56
C43D318101	112	31-81
C43D417101	112	41-71
C43D516101	112	51-61
C43D565601	112	56-56
C43D319101	122	31-91
C43D418101	122	41-81
C43D517101	122	51-71
C43D617101	132	61-71

Cilindro di sicurezza chiave/pomolo incorporato (removibile) Thumb turn cylinder (removable knob)

Dotazione:

- N. 3 chiavi in confezione sigillata
- Tessera duplicazione chiavi
- Vite di fissaggio
- Pomolo Art. 99506/NS
- Finitura nichel satinato

Supplied with:

- 3 keys in a sealed packet
- Owner's card
- Fixing screw
- Knob Art. 99506/NS
- Satin nickel finish



Art. / Art.	A	B - C
C43F313101R	62	31-31
C43F313601R	67	31-36
C43F363101R	67	36-31
C43F314101R	72	31-41
C43F363601R	72	36-36
C43F413101R	72	41-31
C43F314601R	77	31-46
C43F364101R	77	36-41
C43F463101R	77	46-31
C43F413601R	77	41-36
C43F315101R	82	31-51
C43F364601R	82	36-46
C43F414101R	82	41-41
C43F513101R	82	51-31
C43F463601R	82	46-36
C43F315601R	87	31-56
C43F365101R	87	36-51
C43F414601R	87	41-46
C43F563101R	87	56-31
C43F513601R	87	51-36
C43F464101R	87	46-41

Art. / Art.	A	B - C
C43F316101R	92	31-61
C43F365601R	92	36-56
C43F415101R	92	41-51
C43F464601R	92	46-46
C43F613101R	92	61-31
C43F563601R	92	56-36
C43F514101R	92	51-41
C43F465101R	97	46-51
C43F514601R	97	51-46
C43F317101R	102	31-71
C43F416101R	102	41-61
C43F515101R	102	51-51
C43F713101R	102	71-31
C43F614101R	102	61-41
C43F318101R	112	31-81
C43F516101R	112	51-61
C43F565601R	112	56-56
C43F813101R	112	81-31
C43F615101R	112	61-51
C43F319101R	122	31-91
C43F913101R	122	91-31

Cilindro di sicurezza chiave/chiave "Frizionato" "Frictioned" double cylinder



Art. / Art.	A	B - C
C43D3131F1	62	31-31
C43D3136F1	67	31-36
C43D3141F1	72	31-41
C43D3636F1	72	36-36
C43D3146F1	77	31-46
C43D3641F1	77	36-41
C43D3151F1	82	31-51
C43D3646F1	82	36-46
C43D4141F1	82	41-41
C43D3156F1	87	31-56
C43D3651F1	87	36-51
C43D4146F1	87	41-46
C43D3161F1	92	31-61
C43D3656F1	92	36-56
C43D4151F1	92	41-51
C43D4646F1	92	46-46
C43D3166F1	97	31-66

Art. / Art.	A	B - C
C43D3661F1	97	36-61
C43D4156F1	97	41-56
C43D4651F1	97	46-51
C43D3171F1	102	31-71
C43D4161F1	102	41-61
C43D4656F1	102	46-56
C43D5151F1	102	51-51
C43D4661F1	107	46-61
C43D5156F1	107	51-56
C43D3181F1	112	31-81
C43D4171F1	112	41-71
C43D5161F1	112	51-61
C43D5656F1	112	56-56
C43D3191F1	122	31-91
C43D4181F1	122	41-81
C43D5171F1	122	51-71
C43D6171F1	132	61-71

CHAMPIONS® C43

Cilindro di sicurezza chiave/predisposizione pomolo Cylinder with knob provision

Dotazione:

- N. 3 chiavi in confezione sigillata
- Tessera duplicazione chiavi
- Vite di fissaggio
- Finitura nichel satinato

Pomolo non compreso
da ordinare separatamente.

Supplied with:

- 3 keys in a sealed packet
- Owner's card
- Fixing screw
- Satin nickel finish

Knob not included;
order separately.



Art. / Art.	A	B - C
C43F313101	62	31-31
C43F313601	67	31-36
C43F363101	67	36-31
C43F314101	72	31-41
C43F363601	72	36-36
C43F413101	72	41-31
C43F314601	77	31-46
C43F364101	77	36-41
C43F463101	77	46-31
C43F413601	77	41-36
C43F315101	82	31-51
C43F364601	82	36-46
C43F414101	82	41-41
C43F513101	82	51-31
C43F463601	82	46-36
C43F315601	87	31-56
C43F365101	87	36-51
C43F414601	87	41-46
C43F563101	87	56-31
C43F513601	87	51-36
C43F464101	87	46-41

Art. / Art.	A	B - C
C43F316101	92	31-61
C43F365601	92	36-56
C43F415101	92	41-51
C43F464601	92	46-46
C43F613101	92	61-31
C43F563601	92	56-36
C43F514101	92	51-41
C43F465101	97	46-51
C43F514601	97	51-46
C43F317101	102	31-71
C43F416101	102	41-61
C43F515101	102	51-51
C43F713101	102	71-31
C43F614101	102	61-41
C43F318101	112	31-81
C43F516101	112	51-61
C43F565601	112	56-56
C43F813101	112	81-31
C43F615101	112	61-51
C43F319101	122	31-91
C43F913101	122	91-31

Cilindro di sicurezza chiave/predisposizione pomolo regolabile Cylinder with adjustable knob provision

Dotazione:

- N. 3 chiavi in confezione sigillata
- Tessera duplicazione chiavi
- Vite di fissaggio
- Finitura nichel satinato

Pomolo non compreso
da ordinare separatamente.

Supplied with:

- 3 keys in a sealed packet
- Owner's card
- Fixing screw
- Satin nickel finish

Knob not included;
order separately.



Art. / Art.	A	B - C
C43P313101	62	31-31
C43P363101	67	36-31
C43P413101	72	41-31
C43P463101	77	46-31
C43P513101	82	51-31
C43P563101	87	56-31
C43P613101	92	61-31
C43P713101	102	71-31
C43P813101	112	81-31

CHAMPIONS® C43

Mezzo cilindro di sicurezza per serrature spessore 14/20 mm Half cylinder for locks 14/20 mm thickness

Dotazione:

- N. 3 chiavi in confezione sigillata
- Tessera duplicazione chiavi
- Vite di fissaggio
- Finitura nichel satinato

Supplied with:

- 3 keys in a sealed packet
- Owner's card
- Fixing screw
- Satin nickel finish



Mezzo cilindro di sicurezza per serrature spessore 30 mm Half cylinder for locks 30 mm thickness

Dotazione:

- N. 3 chiavi in confezione sigillata
- Tessera duplicazione chiavi
- Vite di fissaggio
- Finitura nichel satinato

Supplied with:

- 3 keys in a sealed packet
- Owner's card
- Fixing screw
- Satin nickel finish



Art. / Art.	A	B
C43M310001	41	31
C43M360001	46	36
C43M410001	51	41
C43M510001	61	51
C43M610001	71	61
C43M710001	81	71
C43M810001	91	81

Art. / Art.	A	B
C43B310001	46	31
C43B410001	56	41
C43B510001	66	51
C43B610001	76	61
C43B710001	86	71
C43B810001	96	81

I mezzi cilindri CHAMPIONS® consentono la regolazione della penna in 8 posizioni diverse. Far rientrare il pernetto con una matita o altro oggetto appuntito e ruotare la penna nella posizione desiderata. Il perno si posiziona automaticamente.

The CHAMPIONS® half cylinder lets you adjust the cam in 8 different positions. Push in the pin with a pencil or other pointed object and turn the cam to the position you want. The pin will position automatically.

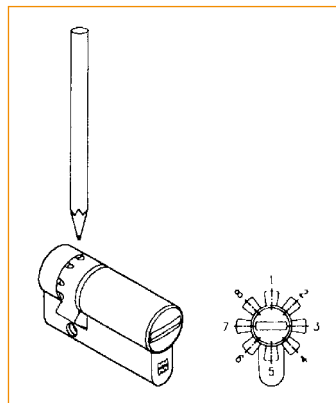

CHAMPIONS® C44

Cilindro di sicurezza chiave/chiave Double cylinder

Dotazione:

- N. 3 chiavi in confezione sigillata
- Tessera duplicazione chiavi
- Vite di fissaggio
- Finitura nichel satinato

Supplied with:

- 3 keys in a sealed packet
- Owner's card
- Fixing screw
- Satin nickel finish



Art. / Art.	A	B - C
C44D313101	62	31-31
C44D313601	67	31-36
C44D314101	72	31-41
C44D363601	72	36-36
C44D314601	77	31-46
C44D364101	77	36-41
C44D315101	82	31-51
C44D364601	82	36-46
C44D414101	82	41-41
C44D315601	87	31-56
C44D365101	87	36-51
C44D414601	87	41-46
C44D316101	92	31-61
C44D365601	92	36-56
C44D415101	92	41-51
C44D464601	92	46-46
C44D316601	97	31-66

Art. / Art.	A	B - C
C44D366101	97	36-61
C44D415601	97	41-56
C44D465101	97	46-51
C44D317101	102	31-71
C44D416101	102	41-61
C44D465601	102	46-56
C44D515101	102	51-51
C44D466101	107	46-61
C44D515601	107	51-56
C44D318101	112	31-81
C44D417101	112	41-71
C44D516101	112	51-61
C44D565601	112	56-56
C44D319101	122	31-91
C44D418101	122	41-81
C44D517101	122	51-71
C44D617101	132	61-71

Cilindro di sicurezza chiave/pomolo incorporato (removibile) Thumb turn cylinder (removable knob)

Dotazione:

- N. 3 chiavi in confezione sigillata
- Tessera duplicazione chiavi
- Vite di fissaggio
- Pomolo Art. 99506/NS
- Finitura nichel satinato

Supplied with:

- 3 keys in a sealed packet
- Owner's card
- Fixing screw
- Knob Art. 99506/NS
- Satin nickel finish



Art. / Art.	A	B - C
C44F313101R	62	31-31
C44F313601R	67	31-36
C44F363101R	67	36-31
C44F314101R	72	31-41
C44F363601R	72	36-36
C44F413101R	72	41-31
C44F314601R	77	31-46
C44F364101R	77	36-41
C44F463101R	77	46-31
C44F413601R	77	41-36
C44F315101R	82	31-51
C44F364601R	82	36-46
C44F414101R	82	41-41
C44F513101R	82	51-31
C44F463601R	82	46-36
C44F315601R	87	31-56
C44F365101R	87	36-51
C44F414601R	87	41-46
C44F563101R	87	56-31
C44F513601R	87	51-36
C44F464101R	87	46-41

Art. / Art.	A	B - C
C44F316101R	92	31-61
C44F365601R	92	36-56
C44F415101R	92	41-51
C44F464601R	92	46-46
C44F613101R	92	61-31
C44F563601R	92	56-36
C44F514101R	92	51-41
C44F465101R	97	46-51
C44F514601R	97	51-46
C44F317101R	102	31-71
C44F416101R	102	41-61
C44F515101R	102	51-51
C44F713101R	102	71-31
C44F614101R	102	61-41
C44F318101R	112	31-81
C44F516101R	112	51-61
C44F565601R	112	56-56
C44F813101R	112	81-31
C44F615101R	112	61-51
C44F319101R	122	31-91
C44F913101R	122	91-31

Cilindro di sicurezza chiave/chiave "Frizionato" "Frictioned" double cylinder



Art. / Art.	A	B - C
C44D3131F1	62	31-31
C44D3136F1	67	31-36
C44D3141F1	72	31-41
C44D3636F1	72	36-36
C44D3146F1	77	31-46
C43D3641F1	77	36-41
C44D3151F1	82	31-51
C44D3646F1	82	36-46
C44D4141F1	82	41-41
C44D3156F1	87	31-56
C44D3651F1	87	36-51
C44D4146F1	87	41-46
C44D3161F1	92	31-61
C44D3656F1	92	36-56
C44D4151F1	92	41-51
C44D4646F1	92	46-46
C44D3166F1	97	31-66

Art. / Art.	A	B - C
C44D3661F1	97	36-61
C44D4156F1	97	41-56
C44D4651F1	97	46-51
C44D3171F1	102	31-71
C44D4161F1	102	41-61
C44D4656F1	102	46-56
C44D5151F1	102	51-51
C44D4661F1	107	46-61
C44D5156F1	107	51-56
C44D3181F1	112	31-81
C44D4171F1	112	41-71
C44D5161F1	112	51-61
C44D5656F1	112	56-56
C44D3191F1	122	31-91
C44D4181F1	122	41-81
C44D5171F1	122	51-71
C44D6171F1	132	61-71

CHAMPIONS® C44

Cilindro di sicurezza chiave/predisposizione pomolo Cylinder with knob provision

Dotazione:

- N. 3 chiavi in confezione sigillata
- Tessera duplicazione chiavi
- Vite di fissaggio
- Finitura nichel satinato

Pomolo non compreso
da ordinare separatamente.

Supplied with:

- 3 keys in a sealed packet
- Owner's card
- Fixing screw
- Satin nickel finish

Knob not included;
order separately.



Art. / Art.	A	B - C
C44F313101	62	31-31
C44F313601	67	31-36
C44F363101	67	36-31
C44F314101	72	31-41
C44F363601	72	36-36
C44F413101	72	41-31
C44F314601	77	31-46
C44F364101	77	36-41
C44F463101	77	46-31
C44F413601	77	41-36
C44F315101	82	31-51
C44F364601	82	36-46
C44F414101	82	41-41
C44F513101	82	51-31
C44F463601	82	46-36
C44F315601	87	31-56
C44F365101	87	36-51
C44F414601	87	41-46
C44F563101	87	56-31
C44F513601	87	51-36
C44F464101	87	46-41

Art. / Art.	A	B - C
C44F316101	92	31-61
C44F365601	92	36-56
C44F415101	92	41-51
C44F464601	92	46-46
C44F613101	92	61-31
C44F563601	92	56-36
C44F514101	92	51-41
C44F465101	97	46-51
C44F514601	97	51-46
C44F317101	102	31-71
C44F416101	102	41-61
C44F515101	102	51-51
C44F713101	102	71-31
C44F614101	102	61-41
C44F318101	112	31-81
C44F516101	112	51-61
C44F565601	112	56-56
C44F813101	112	81-31
C44F615101	112	61-51
C44F319101	122	31-91
C44F913101	122	91-31

Cilindro di sicurezza chiave/predisposizione pomolo regolabile Cylinder with adjustable knob provision

Dotazione:

- N. 3 chiavi in confezione sigillata
- Tessera duplicazione chiavi
- Vite di fissaggio
- Finitura nichel satinato

Pomolo non compreso
da ordinare separatamente.

Supplied with:

- 3 keys in a sealed packet
- Owner's card
- Fixing screw
- Satin nickel finish

Knob not included;
order separately.



Art. / Art.	A	B - C
C44P313101	62	31-31
C44P363101	67	36-31
C44P413101	72	41-31
C44P463101	77	46-31
C44P513101	82	51-31
C44P563101	87	56-31
C44P613101	92	61-31
C44P713101	102	71-31
C44P813101	112	81-31

CILINDRI DI SICUREZZA CHAMPIONS® / CHAMPIONS® SECURITY CYLINDERS

CHAMPIONS® C43-C44

RICAMBI CHAMPIONS® C43-C44 / CHAMPIONS® C43-C44 SPARE PARTS

Statore doppio cilindro per Champions® C43

Shell for double cylinder for Champions® C43

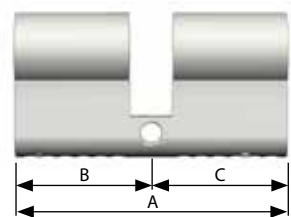

Art. / Art.	A	B - C	Conf. Pack Pz./Pc.
98CS13131	62	31-31	20
98CS13136	67	31-36	10
98CS13141	72	31-41	10
98CS13636	72	36-36	10
98CS13146	77	31-46	10
98CS13641	77	36-41	10
98CS13151	82	31-51	10
98CS13646	82	36-46	10
98CS14141	82	41-41	10
98CS13156	87	31-56	10
98CS13651	87	36-51	10
98CS14146	87	41-46	10
98CS13161	92	31-61	10
98CS13656	92	36-56	10
98CS14151	92	41-51	10
98CS14646	92	46-46	10
98CS13166	97	31-66	10
98CS13661	97	36-61	10
98CS14156	97	41-56	10
98CS14651	97	46-51	10
98CS13171	102	31-71	10
98CS14161	102	41-61	10
98CS14656	102	46-56	10
98CS15151	102	51-51	10
98CS14651	107	46-51	10
98CS15156	107	51-56	10
98CS13181	112	31-81	10
98CS14171	112	41-71	10
98CS15161	112	51-61	10
98CS15656	112	56-56	10
98CS13191	122	31-91	10
98CS14181	122	41-81	10
98CS15171	122	51-71	10
98CS16171	132	61-71	10

Statore doppio cilindro per Champions® C44

Shell for double cylinder for Champions® C44

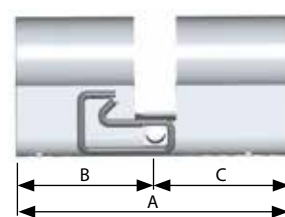

Art. / Art.	A	B - C	Conf. Pack Pz./Pc.
98CS23131	62	31-31	20
98CS23136	67	31-36	10
98CS23141	72	31-41	10
98CS23636	72	36-36	10
98CS23146	77	31-46	10
98CS23641	77	36-41	10
98CS23151	82	31-51	10
98CS23646	82	36-46	10
98CS24141	82	41-41	10
98CS23156	87	31-56	10
98CS23651	87	36-51	10
98CS24146	87	41-46	10
98CS23161	92	31-61	10
98CS23656	92	36-56	10
98CS24151	92	41-51	10
98CS24646	92	46-46	10
98CS23166	97	31-66	10
98CS23661	97	36-61	10
98CS24156	97	41-56	10
98CS24651	97	46-51	10
98CS23171	102	31-71	10
98CS24161	102	41-61	10
98CS24656	102	46-56	10
98CS25151	102	51-51	10
98CS24661	107	46-61	10
98CS25156	107	51-56	10
98CS23181	112	31-81	10
98CS24171	112	41-71	10
98CS25161	112	51-61	10
98CS25656	112	56-56	10
98CS23191	122	31-91	10
98CS24181	122	41-81	10
98CS25171	122	51-71	10
98CS26171	132	61-71	10

Statore mezzo cilindro standard per serrature spessore 14/20mm per Champions® C43

Shell for standard half cylinder for 14/20 mm thickness locks for Champions® C43

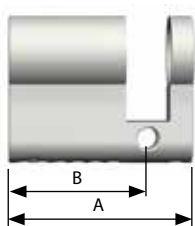

Art. / Art.	A	B	Conf. Pack Pz./Pc.
98CSM3100	41	31	20
98CSM3600	46	36	20
98CSM4100	51	41	20
98CSM5100	61	51	20
98CSM6100	71	61	10
98CSM7100	81	71	10
98CSM8100	91	81	10

Statore mezzo cilindro per serrature spessore 30 mm per Champions® C43

Shell for half cylinder for 30 mm thickness locks for Champions® C43

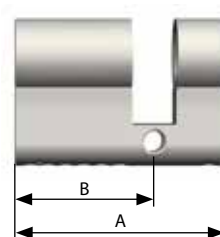

Art. / Art.	A	B	Conf. Pack Pz./Pc.
98CSB3100	46	31	20
98CSB4100	56	41	20
98CSB5100	66	51	20
98CSB6100	76	61	10
98CSB7100	86	71	10
98CSB8100	96	81	10

CHAMPIONS® C43-C44

Rotore per doppio e mezzo cilindro per Champions® C43-C44

Plug for double and half cylinder for Champions® C43-C44



Lunghezza unica per tutte le tipologie di cilindro
All cylinders standard length

Art. / Art.	Conf. Pack Pz./Pc.
98CRV43	30

Rotore pomolo fisso per Champions® C43-C44

Plug for fixed knob for Champions® C43-C44

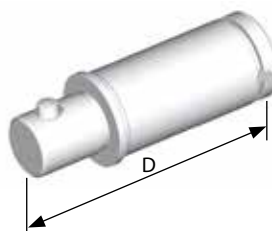

C = quota di riferimento lunghezza cilindro
C = cylinder length reference position

Art. / Art.	C	D	Conf. Pack Pz./Pc.
98C7701230	31	42	5
98C7701235	36	47	5
98C7701240	41	52	5
98C7701245	46	57	5
98C7701250	51	62	5
98C7701255	56	67	5
98C7701260	61	72	5
98C7701270	71	82	5
98C7701280	81	92	5
98C7701290	91	102	5

Rotore pomolo regolabile per Champions® C43-C44

Plug for adjustable knob for Champions® C43-C44

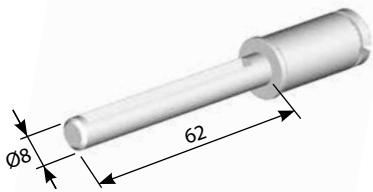

Art. / Art.	Conf. Pack Pz./Pc.
98C77011	5

Distanziale cilindro/tiglia per Champions® C43-C44

Cylinder/stem spacer for Champions® C43-C44

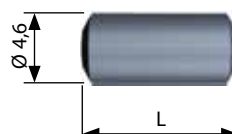

Art. / Art.	L	Conf. Pack Pz./Pc.
98C1908405	5	250
98C1908410	10	250
98C1908420	20	250
98C1908430	30	250

Distanziale per cilindro lato chiave per Champions® C43-C44

Spacer for double cylinder for Champions® C43-C44

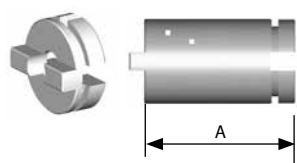

Art. / Art.	C	A	Conf. Pack Pz./Pc.
98C1910605	36	5	5
98C1910610	41	10	5
98C1910615	46	15	5
98C1910620	51	20	5
98C1910625	56	25	5
98C1910630	61	30	5
98C1910640	71	40	5
98C1910650	81	50	5
98C1910660	91	60	5

C = quota di riferimento lunghezza cilindro
C = cylinder length reference position

Distanziale per mezzo cilindro lato opposto alla chiave per Champions® C43-C44

Spacer for half cylinder side opposite the key for Champions® C43-C44

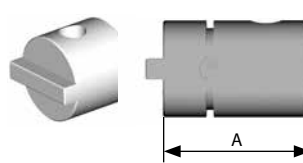

Art. / Art.	C	A	Conf. Pack Pz./Pc.
98C1910711	31	11	5
98C1910716	36	16	5
98C1910721	41	21	5
98C1910731	51	31	5
98C1910741	61	41	5
98C1910751	71	51	5
98C1910761	81	61	5

C = quota di riferimento lunghezza cilindro
C = cylinder length reference position

Molla per Champions® C43-C44

Spring for Champions® C43-C44



Art. / Art.	Conf. Pack Pz./Pc.
98C32116	250

Molla per cilindro con pomolo per Champions® C43-C44

Spring for cylinder with knob for Champions® C43-C44



Art. / Art.	Conf. Pack Pz./Pc.
98C32118	50

CHAMPIONS® C43-C44

Molla per penna mezzo cilindro
per Champions® C43-C44

Spring for half cylinder
for Champions® C43-C44



Art. / Art.	Conf. Pack Pz./Pc.
98C32140	50

Controperno per masterizzazioni
per Champions® C43-C44

Bottom pin for masterizing
for Champions® C43-C44



Art. / Art.	L	Conf. Pack Pz./Pc.
98C37501-1	0,90	250
98C37501-2	1,35	250
98C37501-3	1,80	250
98C37501-4	2,25	250
98C37501-5	2,70	250

Perno controllo profilo chiave
per Champions® C43-C44

Key profile control pin
for Champions® C43-C44

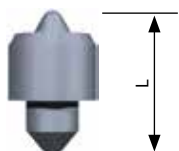

Art. / Art.	L	Conf. Pack Pz./Pc.
98C37503 (laterale/lateral)	5,3	250
98C37503S (superiore/top)	6,05	250

Perno combinazione
per Champions® C43-C44

Anti-picklock top pin
for Champions® C43-C44

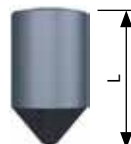

Art. / Art.	L	Conf. Pack Pz./Pc.
98C37504-0	5,55	250
98C37504-1	6	250
98C37504-2	6,45	250
98C37504-3	6,9	250
98C37504-4	7,35	250
98C37504-5	7,8	250
98C37504-6	8,25	250

Controperno
per Champions® C43-C44

Bottom pin
for Champions® C43-C44



Art. / Art.	L	Conf. Pack Pz./Pc.
98C37505-1	4,5	250
98C37505-2	5	250
98C37505-3	5,5	250

Controperno antigiraldello
per Champions® C43-C44

Anti-picklock bottom pin
for Champions® C43-C44



Art. / Art.	L	Conf. Pack Pz./Pc.
98C37506-1	4,5	250
98C37506-2	5	250
98C37506-3	5,5	250
98C37506-30T	5,5	250

Perno per penna mezzo cilindro
per Champions® C43-C44

Pin for half cylinder
for Champions® C43-C44



Art. / Art.	Conf. Pack Pz./Pc.
98C37540	50

Perno combinazione antigiraldello
per Champions® C43-C44

Anti-picklock top pin
for Champions® C43-C44



Art. / Art.	L	Conf. Pack Pz./Pc.
98C37566-1	6	250
98C37566-2	6,45	250
98C37566-3	6,9	250
98C37566-4	7,35	250
98C37566-5	7,8	250

CHAMPIONS® C43-C44

Seeger bloccaggio rotore cilindro
per Champions® C43-C44
Plug retainer for Champions® C43-C44



Art. / Art.	Spessore Thickness	Conf. Pack Pz./Pc.
98C47010	1	250
98C47010-1	0,9	250
98C47010-2	1,1	250

Tappo per Champions® C43-C44
Cap for Champions® C43-C44

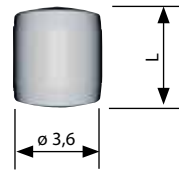

Art. / Art.	L	Conf. Pack Pz./Pc.
98C49012	4	250

Inserto identificazione impugnatura
per Champions® C43-C44
*Grip identification insert
for Champions® C43-C44*



Art. / Art.	Colore Colour	Conf. Pack Pz./Pc.
98C49013R	Rosso/Red	25
98C49013V	Verde/Green	25
98C49013B	Blu/Blue	25
98C49013G	Giallo/Yellow	25
98C49013W	Bianco/White	25

Vite M5x80 mm per Champions® C43-C44
Screw for Champions® C43-C44



Art. / Art.	Conf. Pack Pz./Pc.
98C56123	25

Penna per mezzo cilindro
per Champions® C43-C44
*Cam for half cylinder
for Champions® C43-C44*



Art. / Art.	Conf. Pack Pz./Pc.
98C76000	10-50

Penna per mezzo cilindro con pomolo
per Champions® C43-C44
*Cam for cylinder with knob
for Champions® C43-C44*



Art. / Art.	Conf. Pack Pz./Pc.
98C76001	10-50

Penna per doppio cilindro
per Champions® C43-C44
*Cam for double cylinder
for Champions® C43-C44*



Art. / Art.	Conf. Pack Pz./Pc.
98C76003	10-50

Tigia e penna per doppio cilindro frizionato
per Champions® C43-C44
*Stem and cam for double frictioned cylinder
for Champions® C43-C44*



Art. / Art.	Conf. Pack Pz./Pc.
98CKDF0000	10

RICAMBI CHAMPIONS® C43-C44 / CHAMPIONS® C43-C44 SPARE PARTS

CHAMPIONS® C43-C44

RICAMBI CHAMPIONS® C43-C44 / CHAMPIONS® C43-C44 SPARE PARTS

Sfera per sistemi Vario
Sphere for Vario systems



Art. / Art.	Conf. Pack Pz./Pc.
98C99428	250

Mantonet per Champions® C43-C44
Mantonet for Champions® C43-C44

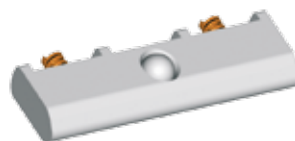

Art. / Art.	Conf. Pack Pz./Pc.
98CAF241	250

Perno seguipista
per Champions® C43-C44
Pin for Champions® C43-C44



Art. / Art.	Conf. Pack Pz./Pc.
98CAF242R_F	250
98CAF242R_G	250
98CAF242R_H	250
98CAF242R_I	250
98CAF242R_J	250

Tigia per cilindro con pomolo
fisso e regolabile per Champions® C43-C44
Stem for cylinder with fixed and
adjustable knob for Champions® C43-C44



Art. / Art.	Conf. Pack Pz./Pc.
98CAF243	50

Lubrificante per cilindri e lucchetti
Lubricating for cylinders and padlocks



NO OIL TO LUBRICATE

NB: per la lubrificazione dei cilindri
e dei lucchetti non usare oli o simili
ma esclusivamente lubrificante Mottura
WARNING: to lubricate cylinders
use only Mottura lubricating

Art. / Art.	Conf. Pack Pz./Pc.
98AF585	1

Tigia per doppio cilindro
per Champions® C43-C44
Stem for double cylinder
for Champions® C43-C44



Art. / Art.	Conf. Pack Pz./Pc.
98CAF508	50

CHAMPIONS® C43-C44



Chiave grezza C43-C44 (riservata ai Mottura Club)
Key blank C43-C44 (reserved, Mottura Club)

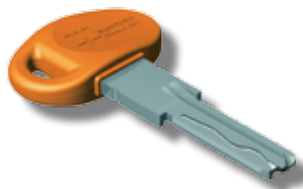

Art. / Art.	Conf. Pack Pz./Pc.
92C43E1	25
92C43E2	25
92C43E3	25
92C43E4	25
92C43E5	25
92C43E6	25
92C43E7	25
92C43E8	25

Gruppo 3 chiavi cifrate con tessera
per duplicazione - Champions® C43-C44
Group of 3 coded keys with owner's card
for Champions® C43-C44



Art. / Art.	Conf. Pack Pz./Pc.
91C43CT	1

Aggiunta o detrazione di chiavi alla normale dotazione
Surcharge or decrease of keys from standard supply



Duplicazione chiave a campione
Key duplication as per sample



RICAMBI CHAMPIONS® C43-C44 / CHAMPIONS® C43-C44 SPARE PARTS



SAFEGUARDING YOUR SECURITY

www.mottura.it

COMPANY WITH QUALITY MANAGEMENT
SYSTEM CERTIFIED
= **ISO 9001:2008** =

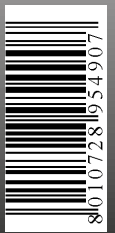

P190380_12 - 06/12 - a_010470